





- PC 4.0 -

Product Numer	Supplier Reference	Diagram Number	Description	Reference	Order Type
11300088			Pullman pc4.0 1200w cannister		W/O
31220349			Hose, complete pullman pc4.0 as4 ver1, 2 button machine end		W/O
31300055			Rod, Telescope S/S 32mm pullman pc6.0,pc4.0		W/O
31110189			Tool, floor gulper 32mm pullman PC6.0, PC4.0		W/O
31130037			Tool, Dusting brush 32mm pullman PC4.0		W/O
31120077			Tool, Crevice 32mm pullman PC4.0		W/O
32200397			Filter, Cloth in frame AS4 PC4.0		W/O
32410219			Bag,filter UNI904 PC4.0 AS4 v2		W/O

- PC 4.0 -

*W/O : Warehouse order
 *S/O : special order
 *REP : Repair centre order

- PC 4.0 -

Product Numer	Supplier Reference	Diagram Number	Description	Reference	Order Type
33101164	18	18	Clip, Tank pullman as4 PC4.0		
33200159	16	16	Cable 9m pullman pc4.0		W/O
33200084	7	7	Switch on/off pullman pc4.0		W/O
34400213	26	26	Motor complete 1200w pullman pc4.0		W/O

- PC 4.0 -

*W/O : Warehouse order
 *S/O : special order
 *REP : Repair centre order

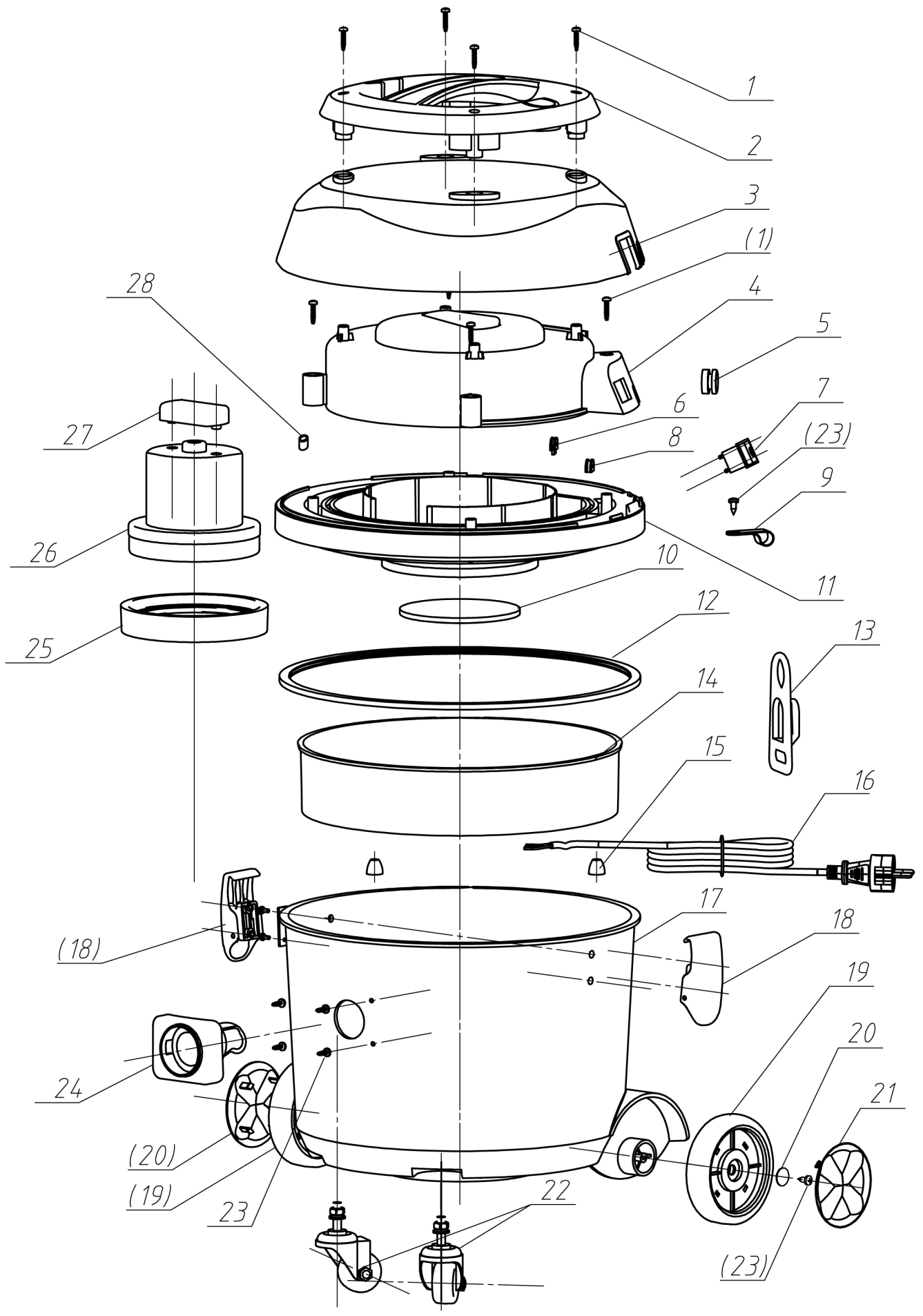

PULLMAN®

THE **BIG** CLEANING CHOICE

PC4.0 VACUUM CLEANER INSTRUCTION MANUAL

READ ALL INSTRUCTIONS BEFORE
USING THIS APPLIANCE

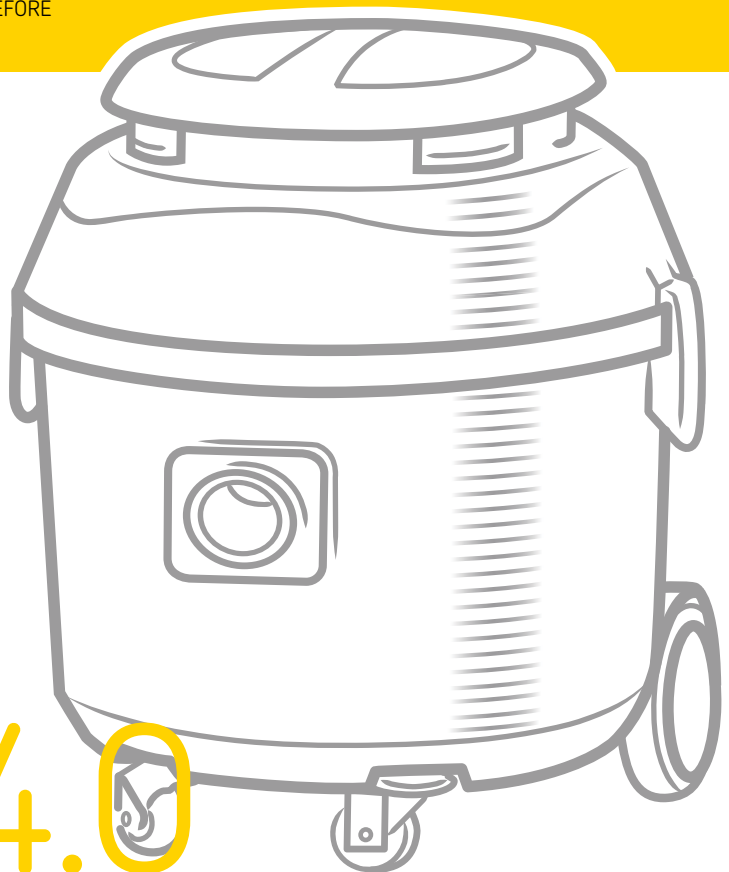

PC4.0

IMPORTANT SAFETY INSTRUCTIONS

Congratulations on your purchase of your new Pullman vacuum cleaner. There are many useful features built into your cleaner and we recommend that you carefully read this instruction book so that you may take best advantage of them.

BEFORE YOU BEGIN

This product must be operated in accordance with these instructions and used only for the removal of DRY dirt and dust. This cleaner is not designed for the collection of vitreous building materials including particle board construction products and similar products such as wood/fibres, sand, cement, fillers, fibre glass etc. The pick-up of these materials may be harmful to your cleaner and will void the manufacturer's warranty.

Safety reminders and taking care of your Pullman cleaner, **PLEASE READ THESE INSTRUCTIONS THOROUGHLY.** This will ensure you obtain full benefit from your new cleaner. Keep this instruction book in a handy place for future reference.

IMPORTANT

Always switch the cleaner off and remove the plug from the electricity supply before cleaning your appliance, when not in use, or attempting any maintenance task. The cleaner must only be connected to an AC supply at the voltage shown on the rating plate. This cleaner should only be used for its intended purpose as described in these instructions.

NEVER OPERATE THE VACUUM CLEANER WITHOUT FILTERS FITTED.

DO NOT pick up hard or sharp objects, matches, hot ashes, cigarette ends or similar items.

DO NOT pick up flammable liquids such as cleaning fluids, petrol etc., or use in the presence of such vapors.

DO NOT use your cleaner out of doors or on any wet surface or for WET pick-up.

DO NOT use the vacuum cleaner with wet hands or with bare feet.

DO NOT put any objects into openings.

DO NOT use with any opening blocked; keep free of dust, lint, hair and anything that may reduce airflow.

DO NOT allow children or the infirm to operate this appliance without supervision. It must not be used on people or animals. Do not allow to be used as a toy.

NEVER run over the supply cord, or use the cord as a carry handle, or pull across sharp edges. Keep cord away from heated surfaces.

Always disconnect the cleaner from the power outlet by pulling out the plug directly, **NEVER** by pulling on the supply cord.

If using an extension cord please make sure that it is of an approved type and that it is fully extended. Failure to do so could cause your cleaner to overheat and damage it.

FAULTS

Do not continue to use the appliance if it appears to be faulty or the supply cord is damaged. If the supply cord is damaged, it must be replaced by the manufacturer or its service agent or a similarly qualified person in order to avoid a hazard.

If a fault cannot be rectified, please return to the point of purchase.

If damaged, return the cleaner for repair by an authorised Pullman Service Centre in order to avoid a safety hazard.

Consult the trouble shooting guide in this manual if your vacuum cleaner fails to operate properly. Contact an authorised service agent if the problem persists.

AFTER USE

Switch the cleaner off and remove the plug from the electricity supply.

Always switch off and remove the plug before attaching any accessories or cleaning the appliance.

PROTECTING THE ENVIRONMENT

When you have unpacked the unit, do not simply throw the packing into the household waste. Take them to an appropriate collecting point for the recycling.

PULLMAN

Model PC4.0

220-240V 50Hz

1200W Max.

App. No: NSW22794



N127

TROUBLE SHOOTING		
PROBLEM	CAUSE	REMEDY
*Motor does not start or stops.	No power supply.	Check cable, plug and socket. If still inoperative, contact service agent.
Suction force gradually decreases.	Dust-bag is full, filters are dirty or suction path is blocked.	Replace dust-bag, clean or replace filters, removed objects from suction path.

* This appliance is fitted with an automatic overload device. Should the appliance stop, switch off and unplug from mains. Check to see if filters are blocked or if the suction path is blocked. Clean or replace filters and remove any obstructions from path. Wait 30 minutes before reconnecting and switching back on.

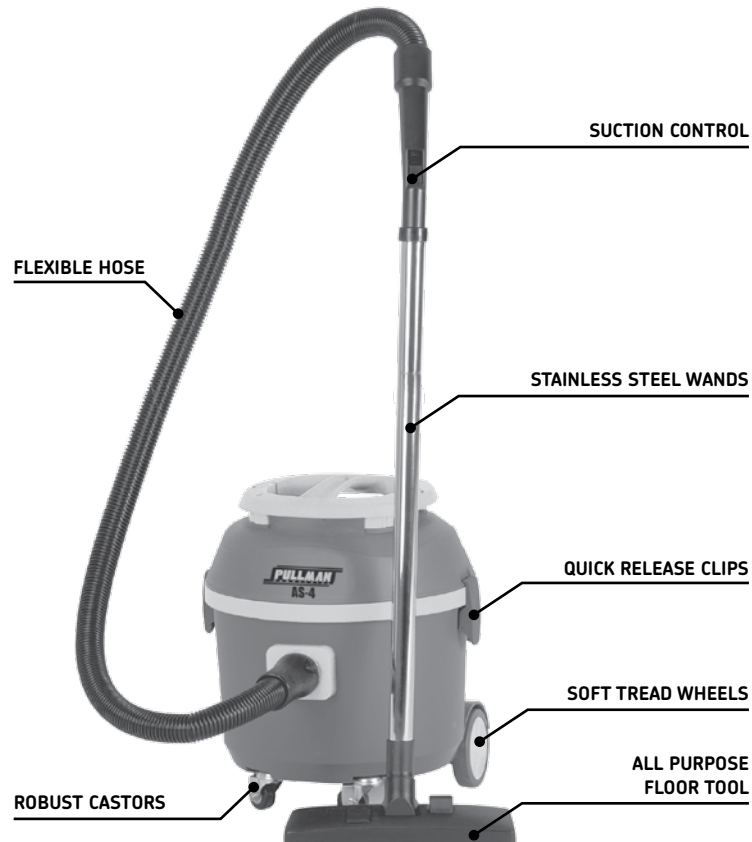

ON-BOARD TOOLS

Your Pullman PC4.0 vacuum cleaner has been designed to handle a number of cleaning chores – effortlessly and efficiently. Accessories including a crevice tool and dusting brush are conveniently located on the top of the cleaner.

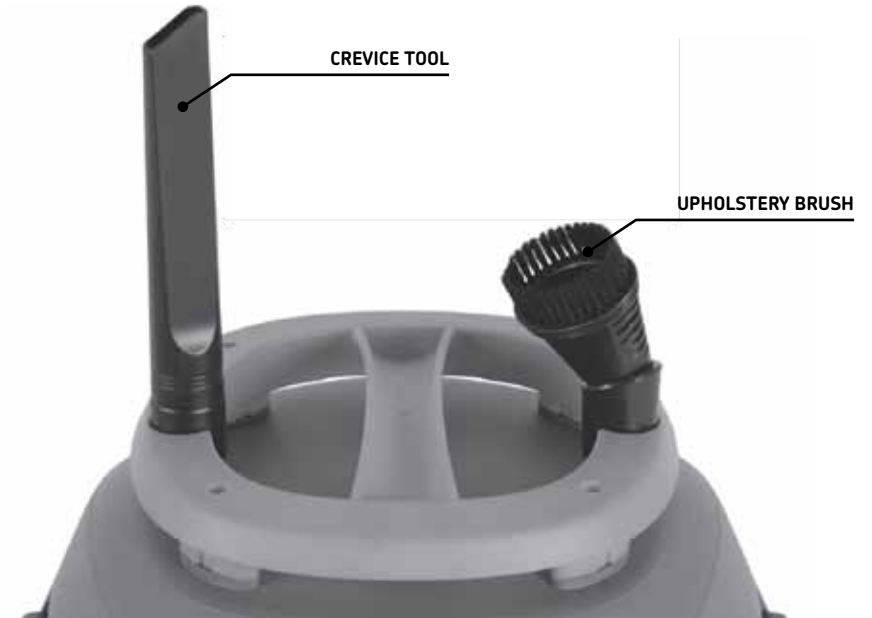

MAINTENANCE

1. Empty the appliance after each use.
2. Fine dust particles can block filters and reduce suction. Check after emptying and when replacing disposable paper bag.
3. Appliance can be used without a paper bag fitted but it's not recommended.
4. Never run appliance without filters fitted or use with damaged filters.
5. Use a dampened cloth to clean exterior of appliance, never use thinners, or petroleum based products as these could damage the thermo-plastic body.

ASSEMBLY, EMPTYING THE CANISTER, CLEANING AND/OR REPLACING FILTERS.



1 After assembling the wands to the hand piece and floor tool, insert the hose into socket.

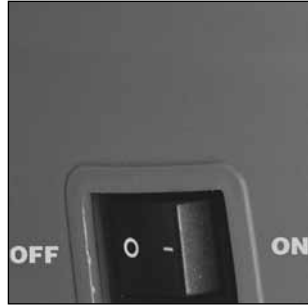

2 Turn the cleaner on by pressing the switch to the ON position. Always turn off when not in use.



3 To empty the cleaner or change filters, disconnect from mains and lift the 2 securing latches.

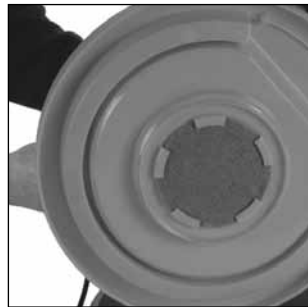

4 Carefully lift lid away from cleaner and remove and replace motor filter if necessary.



5 Remove filter and gently shake off any dust or remove with a soft brush. Replace if necessary.

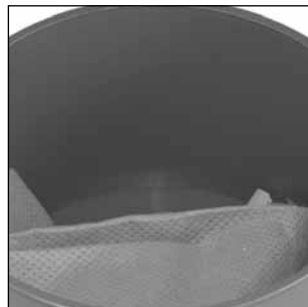

6 Remove full dust bag and dispose. Fit new paper disposable dust bag and reassemble.



**THIS GUARANTEE APPLIES IN AUSTRALIA AND NEW ZEALAND ONLY.
FOR THE GUARANTEE IN ANOTHER COUNTRY, PLEASE CONTACT YOUR
LOCAL RETAILER/DISTRIBUTOR.**

Your new Pullman PC4.0 vacuum cleaner which has been fully tested, inspected and adjusted, carries a 1 year parts and labour guarantee against defects. This cleaner is not designed for the collection of vitreous building material including particle board construction products and similar products such as wood/fibres, sand, cement, fillers, fibreglass etc. The pick-up of these materials may be harmful to your cleaner and will void the manufacturer's warranty. Brushes and filters, unless actually defective in manufacture are not subject to this guarantee since their length of life depends upon usage and care given. Any transportation costs involved in the repair of the appliance or the replacement of a defective part shall be borne by the claimant. This guarantee commences from the date of purchase of the cleaner. When properly used and cared for, your new cleaner will render excellent service, and therefore, the purchaser should carefully read the instruction book, as misuse or failure to follow the instruction book, a misuse or failure to follow the instructions makes this guarantee void. It also becomes void if the product is used on an electric voltage other than that shown on the rating plate. Electrical Home Aids Pty Ltd is unable to accept responsibility under this guarantee for damage from repair work carried out by other than authorised service retailers or centres, or from the use of other than genuine parts. This guarantee does not apply to the cost of replacing any part of the product due to normal wear and tear, alteration, improper installation, physical abuse, misuse or accident. In the event of service or advice being needed, please contact your retailer for your nearest authorised Pullman service agent. Alternatively, please check your local Yellow Pages directly under vacuum cleaners. The benefits conferred by this guarantee are in addition to all other rights and remedies in respect of the product which the consumer has under the Trade Practices Act and other State and Territory laws.

KEEP THIS GUARANTEE AND YOUR RECEIPT AS PROOF OF PURCHASE

Purchase Date / /

Pullman's policy is one of continuous development and accordingly we reserve the right to change specifications without prior knowledge. Contents are copyright. Electrical Home Aids Pty Ltd (ACN 007 539 577) 530 Springvale Rd, Glen Waverley, VIC 3150

THE **BIG** CLEANING CHOICE

Made in China.

Electrical Home Aids Pty Ltd
530 Springvale Rd
Glen Waverley, VIC 3150
Customer Care: 1800 815 270