



USER MANUAL

SMARTWASH+

AUTOMATIC CARPET CLEANER

IMPORTANT: Read all instructions carefully before assembly and use.
This product is intended for Household use only.

©2020 Techtronic Industries Australia Pty Ltd. All Rights Reserved.
31 Gilby Road, Mount Waverley, VIC 3149, Australia



This product meets applicable regulatory requirements



Indoor Use Only



Read Instructions



IPX4



FACS MCW20A

Welcome to HOOVER® ownership.

Make it official.

Register your carpet cleaner by:



Visit Hoover.com.au



Calling 1300 698 130

IT'S GUARANTEED.

Get cleaning confidence for up to 3 years with the HOOVER® limited warranty. See separate warranty card for complete details.

Table of Contents

Safety Instructions	4
Grounding Instructions.....	5
What's in the Box.....	6
Product Guide.....	7
Tools and Accessories.....	8
Before You Begin Cleaning	9
Getting Started	10
How to Assemble Your SmartWash Carpet Cleaner	10
Using your SmartWash Carpet Cleaner	11
Maintenance.....	13
Troubleshooting	20

IMPORTANT SAFETY INSTRUCTIONS

SAVE THESE INSTRUCTIONS

READ ALL SAFETY WARNINGS AND INSTRUCTIONS BEFORE USING THIS

WARNING: When using an electrical product, basic precautions should always be followed to avoid electric shock, fire, and/or serious injury, including the following:

- Fully assemble product prior to use.
- Operate cleaner only at voltage specified on data plate on lower back of cleaner.
- Do not leave appliance when plugged in. Unplug from outlet when not in use and before cleaning or servicing.
- Use indoors only. Do not immerse in water. Use only on surfaces moistened by the cleaning process.
- To Reduce the Risk of Fire and Electric Shock due to internal component damage, use only Hoover® Cleaning Fluids intended for use with this appliance. See the Cleaning Fluid section (page 12) of this manual.
- This appliance is not intended for use by persons (including children) with reduced physical, sensory or mental capabilities, or lack of experience and knowledge, unless they have been given supervision or instruction concerning

use of the appliance by a person responsible for their safety. Children should be supervised to ensure that they do not play with the appliance.

- Use only as described in this manual. Use only manufacturer's recommended attachments and products.
- Do not use product with damaged cord or plug. If product is not working as it should, has been dropped, damaged, left outdoors, or dropped into water, call customer service at 1300 698 130 prior to continuing use.
- Do not pull or carry by cord, use cord as a handle, close a door on cord, or pull cord around sharp edges or corners. Do not place product on cord. Do not run appliance over cord. Keep cord away from heated surfaces.
- Do not unplug by pulling on cord. To unplug, grasp the plug, not the cord.
- Do not handle plug or appliance with wet hands.
- Do not put any object into openings. Do not use with any opening blocked; keep free of dust, lint, hair, and anything that may reduce air flow.
- Keep hair, loose clothing, fingers, and all parts

of body away from openings and moving parts.

- Turn off all controls before unplugging.
- Use extra care when cleaning on stairs. To avoid personal injury or damage, and to prevent the cleaner from falling, always place cleaner at bottom of stairs or on floor. Do not place cleaner on stairs or furniture, as it may result in injury or damage.
- Do not use to pick up flammable or combustible liquids, such as gasoline, or fine wood sandings, or use in areas where they may be present.
- Connect to a properly grounded outlet only. See Grounding Instructions.
- Do not pick up anything that is burning or smoking, such as cigarettes, matches, or hot ashes.
- Do not use without filters and tanks in place.
- Do not clean over floor electrical outlets.

CAUTION: TO REDUCE THE RISK OF DAMAGE:

- Avoid picking up hard, sharp objects with this product, as they may cause damage.
- Store appropriately indoors in a dry place. Do not expose machine to freezing temperatures.
- Do not use sharp objects to clean out hose as they can cause damage.
- To assist in reducing drying time, be certain the area is well ventilated when using detergents and other cleaners with this machine.
- To help prevent matting and resoiling, avoid contact with carpets until they are dry. Keep children and pets away from carpets until they are completely dry.
- Do not store extractor with solution in tanks.
- With brushes on, do not allow cleaner to sit in one location for an extended period of time, as damage to floor can result.
- **DO NOT USE THIS EXTRACTOR ON HARD FLOORS. USING THIS PRODUCT ON HARD FLOORS MAY SCRATCH OR DAMAGE YOUR FLOOR.**
- Water will drip from the brushes and underside of the product after use and may puddle. To avoid damage to wood and laminate flooring and to avoid potential slip hazard, after use (a) do not leave the product on wood and laminate surfaces and remove to a hard surface and (b) place unit on absorbent material (such as a towel) to soak up drips.

GROUNDING INSTRUCTIONS:

This appliance must be grounded. If it should malfunction or breakdown, grounding provides a path of least resistance for electric current to reduce the risk of electric shock. This appliance is equipped with a cord having an equipment-grounding conductor (C) and grounding plug (A). The plug must be inserted into an appropriate outlet (B) that is properly installed and grounded in accordance with all local codes.

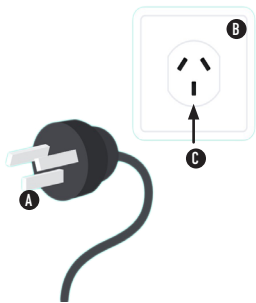

WARNING:

Improper connection of the equipment-grounding conductor can result in the risk of electric shock. Check with a qualified electrician or service person if you are in doubt as to whether the outlet is properly grounded. Do not modify the plug provided with the appliance - if it will not fit the outlet, have a proper outlet installed by a qualified electrician.

The motor is equipped with a thermal cut-out. If for any reason the machine should overheat, the thermostat will automatically turn the machine off.

Should this occur, unplug the machine from the electrical outlet and turn off the switch. Allow the machine to cool for approximately one (1) hour before reusing.

Hoover recommends the use of a Residual Current Device rating of 30mA or less.

Use only Australian approved 10amp extension cords. Care should be taken to arrange the extension cord to prevent it being a trip hazard.

What's in the Box?

Carpet Cleaner

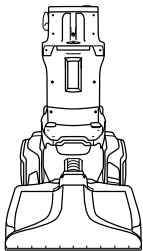

Solution Tank

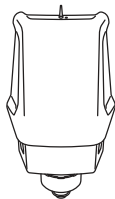

Upper Handle

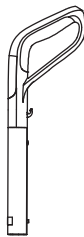

Accessory Hose

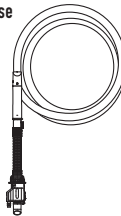

SpinScrub Tool

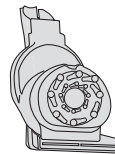

2-in-1 Accessory Tool

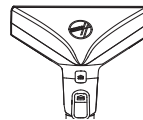

Clean Water Tank



Dirty Water Tank

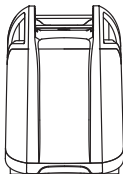

FlexForce™ PowerBrushes

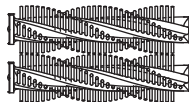

Mesh Tool Storage Bag



Bottle of Cleaning Solution



Getting to Know Your HOOVER® SmartWash

1. Triggerless Handle Design
2. Clean Water Tank
3. Filter
4. Dirty Water/Recovery Tank
5. Hose Connection
6. Removable Recovery Nozzle
7. Automatic Wash/
Dry LED Display
8. Removable FlexForce™ PowerBrushes
9. Solution Tank
10. Carry Handle
11. Cord Wrap
12. Handle Release Pedal
13. On/Off Pedal

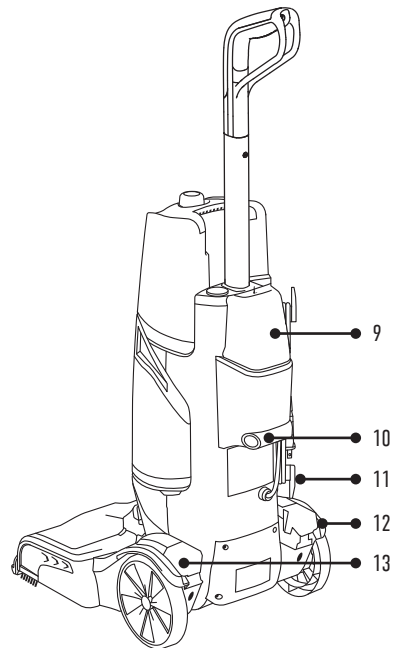
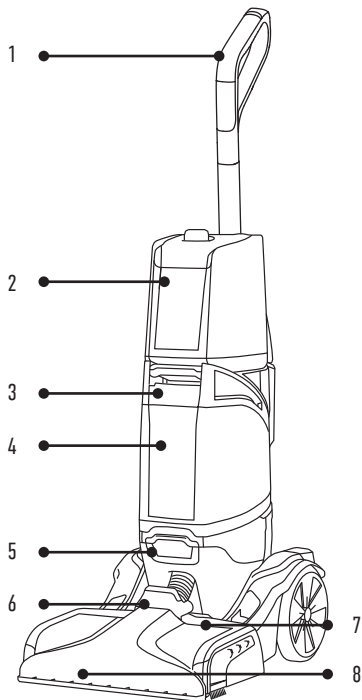

Tools & Accessories:



Not to be used for grooming a pet.

2-in-1 Tool:

Accessory tool that helps prevent bacteria growth and odors allows you to choose between two inserts.

A. The rubber nub insert is for unpleasant stain removal and hygienic clean ups

B. The bristle insert is for tough scrubbing power

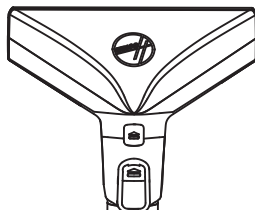

A.

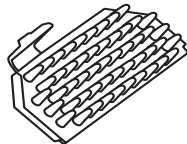

B.

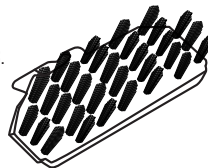

SpinScrub Tool

For above-floor tasks, the cleaner comes with an hose and a stair/upholstery tool, and a SpinScrub hand tool with rotating brushes

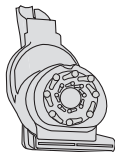

Before You Begin Cleaning:

Vacuum carpet and upholstery thoroughly before use.

Don't use the carpet cleaner as a traditional vacuum cleaner.

Check the label on your upholstery to make sure it is suitable for wet cleaning before using your HOOVER® carpet cleaner.

Test for colorfastness in a small, hidden area. Gently rub surface with a dampened white cloth. Wait ten minutes and check for color removal or bleed with a white paper towel.

Move furniture out of area to be cleaned. Place aluminum foil or wax paper under legs of furniture too heavy to move to prevent wood finishes from staining carpet. Pin up furniture skirts and drapes.

Pretreating:

For best results, pretreat stains with a HOOVER® spot treatment (See HOOVER® Cleaning Solutions Guide) to help loosen and remove even the most stubborn stains.

Available at additional cost if not included with your model.

NOTE: To prevent staining, use plastic or aluminum foil to protect wood or metal surfaces from possible water spray.

NOTE: To avoid damage to wood floors underneath area rugs or carpet, place waterproof material (ex: plastic) underneath them before cleaning.

▲CAUTION▲

Do not clean over floor electrical outlets. Water will drip from the brushes and underside of the product after use and may puddle. To avoid damage to wood and laminate flooring and to avoid potential slip hazard, after use (a) do not leave the product on wood and laminate surfaces and move to a hard surface and (b) place cleaner on an absorbent material (such as a towel) to soak up drips.

IMPORTANT: For full suction, it is important that the Dirty Water Tank is properly secured before cleaning.

Continue using dry strokes until little water is visibly passing through the Nozzle.
For best results, HOOVER® recommends rinsing carpet with water only. This removes residual carpet cleaning solution. Remove Solution Tank and repeat. For heavily soiled areas, repeat. Avoid saturating carpet.

NOTE: Empty Dirty Water Tank when the motor sound becomes higher pitched and there is a loss in suction (see "Automatic shut-off"). You will also see the float rise and shut off suction at the same time.

IMPORTANT: Only use approved Hoover Carpet Washer solutions in your Hoover Smartwash machine to avoid invalidating the warranty. Using other detergents may invalidate the warranty.

TECHNICAL SPECIFICATIONS

NAME	HOOVER SMARTWASH AUTOMATIC CARPET CLEANER		
MODEL	FACSMCW20A		
VOLTAGE	220-240V ~50Hz	CLEAN TANK	3.8 LITRE
WATTAGE	1200W	DIRTY TANK	2.1 LITRE
CORD	9M	SOLUTION TANK	450 ML
WEIGHT	8.2KG		

IPX4



This product meets applicable regulatory requirements



Indoor Use Only



Read Instructions



Subject to technical change without notice

Getting Started With Your SmartWash Carpet

Fully assemble before operating.

Assembly

- 1 Slide the handle into the base until you hear a "click".

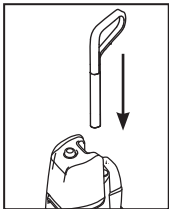

- 2 Wrap the power cord around the cord hooks for convenient storage.

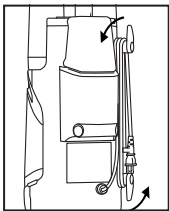

Fill the Clean Water Tank

- 1 Lift up to remove the Clean Water Tank.

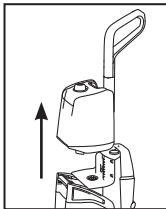

- 2 Remove the cap and add warm water to the top of tank. Replace cap.



- 3 Align Clean Water Tank with the body of the cleaner and press FIRMLY into place.

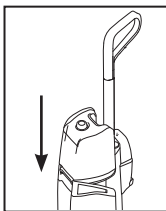

Fill the Solution Tank

- 1 Remove the Solution Tank from the back of the cleaner.

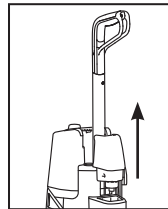

- 2 Remove the cap and fill with HOOVER® Cleaning Solution to the top of the tank. Replace cap.

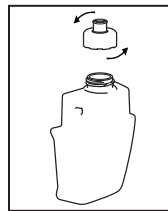

- 3 Place the Solution Tank back into the cleaner and press FIRMLY into place.

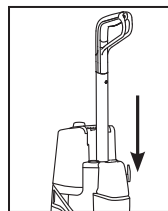

IMPORTANT:

Screw the solution tank cap tightly when refitting. Do not leave the solution stored in the tanks between uses. Unused solution can be poured back into the bottle.

Using Your SmartWash Carpet Cleaner

⚠ CAUTION ⚠

Not to be used for grooming a pet.

- 1 Unwrap the power cord and plug cleaner in an electrical outlet.

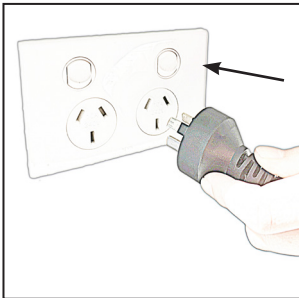

- 2 Step on the Handle Release Pedal to recline the cleaner to cleaning position.

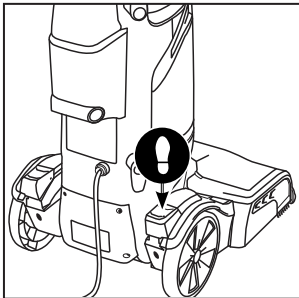

- 3 Step on the On/Off Pedal to turn ON.

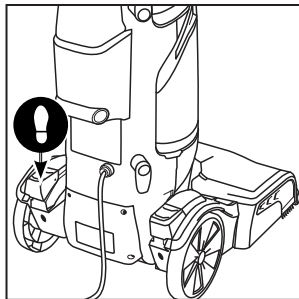

Using Your SmartWash Carpet Cleaner

- 4 Slowly move forward. The cleaner will automatically dispense the optimal amount of water and cleaning solution.

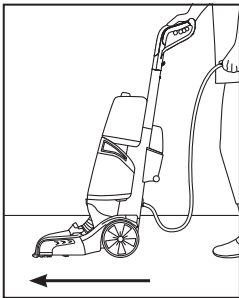

- 5 Slowly pull backward. The cleaner will automatically dry your carpets by extracting the water and cleaning solution.

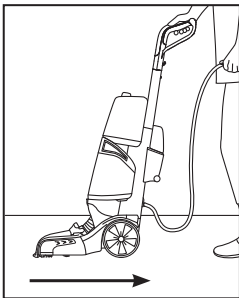

- 6 When you finish cleaning but further drying is required, press the DRY ONLY BUTTON. The Dry Only mode will extract remaining water from your carpet. Continue in this mode until little water is visibly passing through the Nozzle.

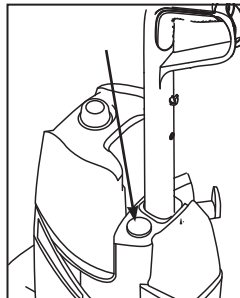

- 7 For best results, HOOVER® recommends rinsing the carpet with clean water only. This will remove residual carpet cleaning solution from your carpets. To rinse with clean water only, remove the Solution Tank and then repeat steps 4 through 6.

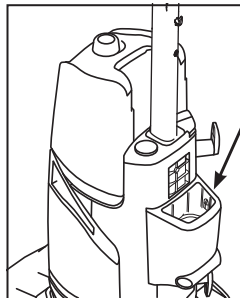

CLEANING FLUID

SEE THE HOOVER'S SOLUTIONS GUIDE insert.

Maintenance

How to Empty

This product contains no serviceable parts.

If appliance is not working as it should, has been dropped, damaged, left outdoors, or dropped into water, call customer service at 1300 698 130

- 1 Turn the cleaner off and unplug from electrical outlet.

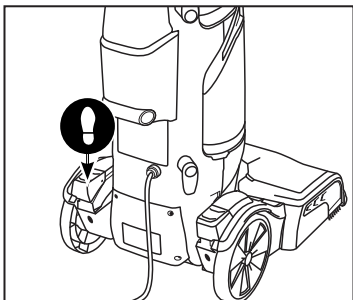

- 2 Grab the Dirty Water Tank handle and pull up to release. Remove Tank from carpet cleaner base at an angle.

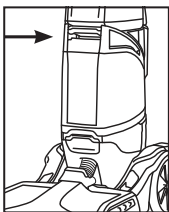

- 3 Place on a flat surface and unlatch Dirty Water Tank lid to remove top

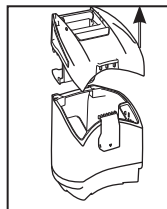

- 4 Empty tank, rinse, wipe filter clean and allow to air dry.

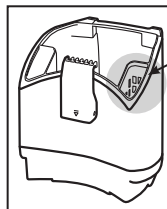

Keeping the filter clean is critical to maintain strong suction performance.

Auto Shut Off Float: Your carpet cleaner is equipped with a shut off float within your Dirty Water Tank. When the Dirty Water Tank becomes full, the float will rise, shutting off the air flow through the Nozzle. Once the air flow is shut off, empty the Dirty Water Tank.

Notices

IMPORTANT: Regarding the Dirty Water Tank: For full suction it is important that the Dirty Water Tank Lid is securely in place. If misplaced, poor or no suction will result.

IMPORTANT: For full suction, it is important that the Dirty Water Tank is properly secured before cleaning.

Continue using dry strokes until little water is visible passing through the Nozzle.
For best results, HOOVER® recommends rinsing carpet with water only. This removes residual carpet cleaning solution. Remove Solution Tank before rinsing carpet.
For heavily soiled areas, repeat. Avoid saturating carpet.

NOTE: Empty Dirty Water Tank when the motor sound becomes higher pitched and there is a loss in suction (see “Automatic shut-off”). You will also see the float rise and shut off suction at the same time.



Do not clean over floor electrical outlets. Water will drip from the brushes and underside of the product after use and may puddle. To avoid damage to wood and laminate flooring and to avoid a potential slip hazard, after use (a) do not leave the product on wood and laminate surfaces and move to a hard surface and (b) place cleaner on an absorbent material (such as a towel) to soak up drips.

Maintenance

How to Remove and Clean Nozzle

⚠ WARNING ⚠
Risk of personal injury – Brush roll may suddenly restart – unplug before cleaning or servicing.

⚠ IMPORTANT ⚠
The Nozzle must be in the proper position for the cleaner to have proper suction.

1 To prevent possible leaking, remove and empty Clean Water Tank, Dirty Water Tank and

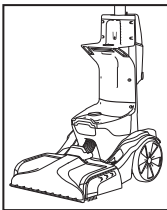

2 With handle in upright position, lift up on the Nozzle release then pull Nozzle forward to remove from carpet cleaner. CAUTION, pull Nozzle carefully outwards and not upwards.

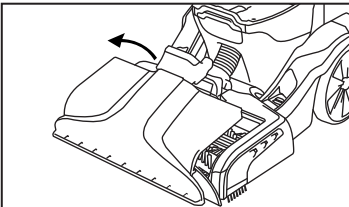

3 Rinse debris from Nozzle.

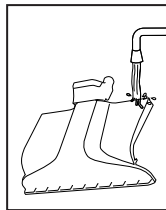

4 Position Nozzle onto foot, making sure to align the tabs at the top of the Nozzle with the notches inside the foot.

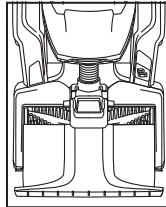

5 Slide Nozzle forward to snap into position.

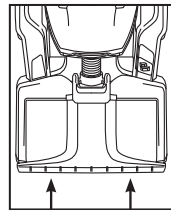

Maintenance

How to Change and Clean Brushes

HOW TO REMOVE

- 1 To prevent possible leaking, remove Clean Water Tank, Dirty Water Tank and Solution Tank.

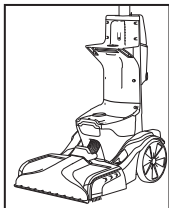

- 2 With handle in upright position, follow "Nozzle: How to Remove and Clean" instructions (page 15).

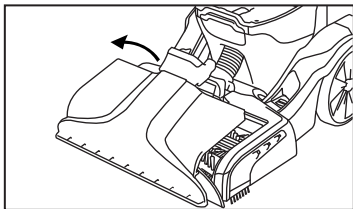

STORAGE

Before storing: Empty Clean Water Tank and let air dry. Replace on cleaner. Empty Dirty Water Tank, clean filter of dirt/debris, rinse tank and lid thoroughly with clean water and let air dry. Empty Solution Tank, rinse tank with clean water and let air dry.

Allow brushes and underside of carpet cleaner to air dry thoroughly before storing carpet cleaner on a carpeted or wood surface.

⚠ WARNING ⚠

Risk of personal injury – Brush roll may suddenly restart – unplug before cleaning or servicing.

- 3 Grab Side A and pull up to remove. Repeat on the other brush.

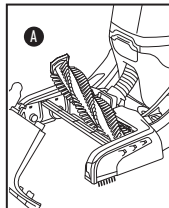

- 4 The brushes can be cleaned under running water.

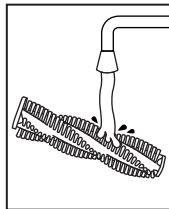

CORD STORAGE

Wrap the power cord around the cord hooks for convenient storage. Attach the plug end to the cord.

LUBRICATION

The motor and brush rolls are equipped with bearings which contain sufficient lubrication for their lifetime.

The addition of lubricant could cause damage. Do not add lubricant to motor bearings or brush rolls.

HOW TO REPLACE

- 1 At an angle, align side B on the brush to the drive gear.

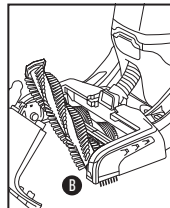

- 2 Press Tab A down until brush snaps in place.

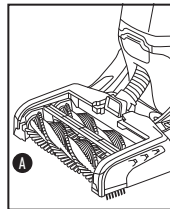

Tools and Accessories

HOW TO ATTACH HOSE

- 1 Open Hose Connection Port. Insert hose end by inserting **FIRMLY** into Hose Solution Port.

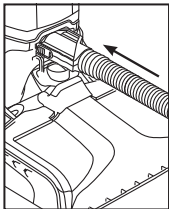

⚠ CAUTION ⚠

Always turn off this product before connecting or disconnecting hose.

HOW TO REMOVE HOSE

- 1 Press trigger on tool to ensure all fluid has discharged from the hose. Press button on end of hose and pull to remove hose and solution connection from
- 2 Close the Hose Port Door back into place. Make sure to close door to ensure proper suction. Cleaner may lose suction if not closed properly.

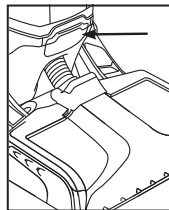
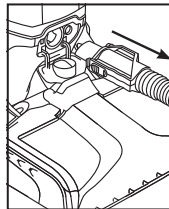

Tools and Accessories

How to Attach Tools

- 1 To ensure maximum performance and to protect your carpet, be sure to place the handle in the upright position while using the hose. Placing the handle in the upright position shuts off the FlexForce™

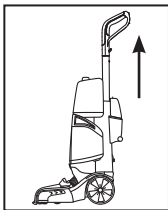

- 2 Connect tool to hose by sliding it onto the connector until it securely locks into place.

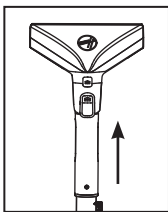

Not to be used for grooming a pet.

- 3 Using your thumb, push forward and up on the latch to remove tool.

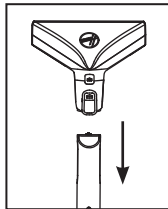

NOTE: Do not place cleaner at top of stairway. To avoid falling down stairs, place cleaner at bottom of stairs and work up.

Tools and Accessories vary per model.

Tools and Accessories

⚠ CAUTION ⚠

Use extra care when cleaning on stairs. To avoid personal injury or damage, and to prevent the cleaner from falling, always place cleaner at the bottom of stairs or on floor. Do not place cleaner on stairs or furniture, as it may result in injury or damage.

Cleaning Carpeted Stairs and Upholstery

- 1 Read "Before you Begin Cleaning" instruction on page 9.
- 2 Attach hose as instructed (page 18).
- 3 Place handle in upright position. FlexForce™ PowerBrushes will not rotate while handle is in upright position.
- 4 Fill Clean Water Tank according to instructions.
- 5 Fill Solution Tank with HOOVER® solution according to instructions on page 10.
- 6 Attach tool to end of hose.
- 7 Dry hands and plug cleaner into a properly grounded outlet.
- 8 Pre-spray the area by holding the tool about one inch above the carpet and push it forward while pressing the trigger.
- 9 Slightly press the tool into area cleaning. Press the trigger and pull the tool slowly over the carpet. Release trigger at end of stroke.
- 10 Lift tool, and position it against Nozzle. Pull tool slowly over carpet without pressing trigger.
- 11 Slightly overlap strokes to help prevent streaking.
- 12 It is best to alternate wet and dry strokes as described in

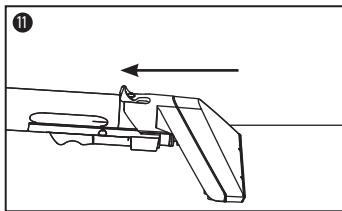
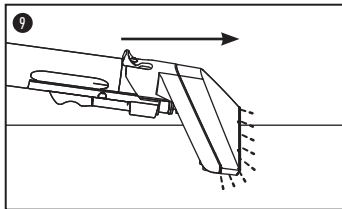

Tips

To avoid saturating carpet, do not use more than 4 wet strokes over any one area. Always end with dry strokes.

If additional cleaning is necessary, wait until the carpet is completely dry before using the tool again.

Empty Dirty Water Tank when the motor sound becomes higher pitched and there is a loss of suction. You will also see the float rise and shut off suction at the same time.

When finished cleaning, follow "After Cleaning" and "After Using Tool" instructions.

Need Help?

If you need further assistance:

If your product needs servicing within the warranty period, please contact Customer Service at 1300 698 130; Mon-Fri 08:30am-5pm.

Always identify your carpet washer by the complete model number when requesting information or ordering parts. (The model number of the carpet washer is located on the data plate).

Troubleshooting:

This product contains no servicable parts..

If appliance is not working as it should, has been dropped, damaged, left outdoors, or dropped into water, call Customer Service at 1300 698 130 for further instruction before continuing use.

USE TROUBLESHOOTING GUIDE AS A FIRST STEP TO RESOLVE ANY PROBLEMS YOU MAY BE EXPERIENCING.

QUESTIONS OR CONCERNS?

Contact Us: 1300 698 130

If you have any questions, visit Hoover.com.au

See back of product for model number.

Troubleshooting:

PROBLEM	POSSIBLE CAUSE	POSSIBLE SOLUTION
Cleaner won't run	<ol style="list-style-type: none"> 1. Not firmly plugged in 2. No voltage in wall plug 3. Blown fuse or tripped breaker 4. Fuse in cleaner blown 5. On/Off pedal not depressed 	<ol style="list-style-type: none"> 1. Plug unit in firmly. 2. Check fuse or breaker in home. 3. Replace fuse or reset breaker in home. 4. Take to service center. 5. Press pedal.
Low suction	<ol style="list-style-type: none"> 1. Dirty Water Tank full/automatic shut off engaged 2. Blockage in tool on end of hose 3. Dirty Water Lid not on correctly 4. Dirty Water Tank Debris Filter clogged 5. Blockage in Nozzle 6. Dirty Water Tank not properly secured 7. Dirty Water Nozzle not on correctly 8. Blockage in hose 	<ol style="list-style-type: none"> 1. Remove and empty Dirty Water Tank. See "How to Empty" page 13. 2. Remove tool and clear blockage. 3. Make sure lid is on securely. See "How to Empty" page 13. 4. See "How to Empty" page 13. 5. See "How to Clean" page 15. 6. Replace Dirty Water Tank and secure Dirty Water Tank latch. 7. Remove and replace Dirty Water Nozzle. See "How to Clean & Remove Nozzle" page 15. 8. Drop a coin through, clear with broom handle.
Hose Nozzle stops spraying liquid during use	<ol style="list-style-type: none"> 1. Clean Water Tank or Detergent Container is empty 2. Loose connection to solution port on foot of cleaner 	<ol style="list-style-type: none"> 1. Turn off Cleaner and fill Clean Water tank & Detergent Container. 2. Check for secure connection to solution port on body of Cleaner.
Accessory Tool will not spray after filling the Clean Water Tank or Solution Tank	<ol style="list-style-type: none"> 1. Air is trapped in the hose & pump 	<ol style="list-style-type: none"> 1. Turn on the Cleaner. If hose does not spray, prime the pump by lowering the hose down to the floor and hold the trigger for up to one minute. 2. Aim downward & squeeze trigger.
Hose will not spray after priming pump	<ol style="list-style-type: none"> 1. Pump is defective 2. Not connected properly 	<ol style="list-style-type: none"> 1. Call for service: 1300 698 130. 2. Check connection.
Clean water won't dispense	<ol style="list-style-type: none"> 1. Clean Water Tank or Solution Tank not firmly in place 2. Clean Water Tank or Solution Tank empty 	<ol style="list-style-type: none"> 1. Make sure tank is securely locked in position. 2. Refill container according to cleaning instructions.
Solution won't dispense	<ol style="list-style-type: none"> 1. Cleaner is not moving in forward direction 	<ol style="list-style-type: none"> 1. Must be moving the machine forward to properly dispense water and solution.
Brushes won't rotate during floor cleaning	<ol style="list-style-type: none"> 1. Brush roll stall protection activated 2. Unit in upright position 	<ol style="list-style-type: none"> 1. Turn the unit off and back on, then inspect and clean for jams. 2. Brushes will not rotate in upright position. Step on handle release to start cleaning.
Water is leaking out of Carpet Cleaner	<ol style="list-style-type: none"> 1. Clean Water Tank, Solution Tank or Dirty Water Tank not FIRMLY in place 	<ol style="list-style-type: none"> 1. Make sure the tank is secure. 2. Carpet Cleaner may drip residual moisture after use. Allow cleaner and brushes to dry before storing on hard floor surface.
Cleaner leaking solution	<ol style="list-style-type: none"> 1. The solution tank cap may not be tightly fitted or may be incorrectly fitted. 	<ol style="list-style-type: none"> 1. Remove the solution tank and screw the solution tank cap tightly before refitting the solution tank back into the machine.



WARNING

To reduce the risk of personal injury, unplug before cleaning or servicing.



®

Hoover.com.au